

# ERGO F21

03/2022

[www.hetronic.com](http://www.hetronic.com)



# User Manual

## Table of Contents

1. Safety .....	4
1.1 Intended Use .....	4
1.2 Symbol Notation .....	4
1.3 Practices and Laws.....	4
1.4 Required Operator Training .....	4
1.5 Possible Sources of Danger .....	5
1.6 Protective Features.....	5
1.7 STOP in case of EMERGENCY .....	5
1.8 Caring for your ERGO F21 Transmitter.....	5
2. Introduction and Functional Description .....	6
2.1 Production and System Numbers .....	6
2.2 Before Operating Your Wireless Control Unit.....	6
2.3 Unit Labels .....	6
3. Your ERGO F21 Transmitter.....	7
3.1 General Description.....	7
3.2 ERGO F21 Basic Features .....	7
4. Product Description .....	8
5. Operating Your Transmitter.....	9
5.1 Holding Your Transmitter.....	9
5.2 Visually Checking Your Transmitter .....	9
5.3 Powering ON and Starting Your Transmitter .....	9
5.4 Transmitter Initialization with Standard Status LED Indicator .....	9
5.5 Transmitter Initialization with Graphic User Interface (LCD) and Status LED Indicator .....	9
5.6 Stopping the Radio Remote Control.....	10
5.7 Battery 'State of Charge' Indication.....	10
5.8 LED Behaviour and Meanings .....	10
5.9 Powering OFF the Transmitter.....	11
5.10 Belts .....	11
6. Generic Radio Remote System functionalities .....	12
6.1 START Function.....	12
6.2 STOP Function .....	12
6.3 Digital Functions.....	12
7. Setting up your ERGO F21 Transmitter for Operation .....	14
7.1 Coder .....	14
7.2 Communication.....	14
7.3 DK Telegram .....	15
7.4 LCD Backlight.....	15
7.5 LCD Welcome Note.....	16
7.6 LCD and LED Feedback .....	16
8. Theory of Operation.....	19
9. Installing the Radio Remote Control.....	20
10. Troubleshooting.....	21
11. Warranty, Service, Repairs and Maintenance .....	22
12. Regulatory Information.....	23
12.1 Europe.....	23
12.2 North America.....	23
12.3 Industry Canada (IC/ISED) Statement .....	24
Appendix A .....	26
Definition of terms.....	26
Appendix B .....	27
B.1 Operator Safety Basics.....	27
B.2 Safety Checklist .....	27

**List of Figures**

Figure 1. *Product Rating Plate* ..... 6  
 Figure 2. *Ergo F21 Transmitter (Left, Front, Right)*..... 8  
 Figure 3. *PC H-Link assignment of digital control channels to push buttons*..... 13  
 Figure 4. *PC H-Link configuration of radio frequency band, frequency channels and bit rate* ..... 14  
 Figure 5. *Auto off time configuration options* ..... 14  
 Figure 6. *32DK telegram assignment as default configuration*..... 15  
 Figure 7. *Backlight configuration options*..... 15  
 Figure 8. *Welcome note graphic configurator*..... 16  
 Figure 9. *4-bit LCD feedback configuration* ..... 16  
 Figure 10. *LCD Text mode*..... 17  
 Figure 11. *Standard Graphic display programming mode using PC H-Link LCDxA library* ..... 17  
 Figure 12. *LED feedback configuration* ..... 18  
 Figure 13. *Feedback LED status configuration options* ..... 18  
 Figure 14. *Inserting Battery*..... 2  
 Figure 15. *3.6V 2.75Ah NiMH Battery* ..... 1  
 Figure 16. *Charger plug variations*..... 1

**List of Tables**

Table 1. *Functional Description* .....8  
 Table 2. *Troubleshooting tips* ..... 21

**Product Specification Sheets**

Transmitter Specifications..... 1  
 Battery & Charger ..... 2  
 Battery Types and Specifications ..... 1  
 MINI UCH 2 Battery Charger ..... 1

**List of Figures**

- Charging the MINI Battery
- Charger plug variations

**List of Tables**

- 3.6V 2.75Ah MINI Battery Technical Specification
- List of UCH 2 Charger Variants

# 1. Safety

## 1.1 Intended Use

Your radio remote control is designed for remote operation of machines and systems using safe wireless communications technology. Any modification, reconstruction, or extension of the systems without a written agreement of Hetriconic may lead to the loss of your warranty and guarantee claims.

Hetriconic assumes no liability for damages resulting out of the non-observance of this operating manual. All persons, working with this radio remote control must



- Be suitably trained and qualified as required by the safety regulations.
- Strictly comply with the contents of this operating manual.

Before starting the radio remote control you must have read and fully understood this operating manual. The safety checklist in Appendix B must be followed each time before the transmitter is powered up for operation.

## 1.2 Symbol Notation

The following symbols are used in this operating manual. The safety alert symbol is used in decals on the unit and with proper operation procedures in this manual.

Understand the safety message. It contains important information about personal safety when using the product.

	<b>STOP!</b> This symbol gives you warning of imminent danger of life, risk of accident and risk of injury, as well as damage to property in case of non-observance of the working instructions.
	<b>ATTENTION!</b> This symbol advises against a possible damage to the system in case of non-observance of the working instructions.
	<b>TIP!</b> This symbol points to features and information which allow for an easier handling or operation.

## 1.3 Practices and Laws

Practice safe working precautions for your own benefit and others.

Be alert to unsafe conditions and the possibility of minor, moderate, or serious injury or death. Learn applicable rules and laws in your working environment or region.

## 1.4 Required Operator Training

The original purchaser of this unit was instructed by the seller on safe and proper operation. If unit is used by someone else other than the original purchaser, loaned, rented or sold, ALWAYS provide this manual and any needed safety training before operation. ALWAYS read and understand the user manual for any machine controlled by this radio remote control.

## 1.5 Possible Sources of Danger

This device is part of a system that makes remote control via wireless radio signals possible. The transmission of control commands can take place around obstacles and out of the operator's direct line of sight. Take the following precautions to prevent accidental start-up and possible injury or damage:



Switch "OFF" the transmitter when it is not in use. Unless the transmitter has user access control password configured, remove the battery if unit is placed away from the operator.



Disconnect the power supply from the receiver before any assembly, maintenance or repair work is done.



**AVOID SYSTEM DAMAGE - ALWAYS** disconnect receiver power supply and control wiring before welding on any part of the machine.



**NEVER** remove or alter any of the safety features.



**ALWAYS** confirm that the machine and radio remote control Stop functions work properly **BEFORE** beginning any machine operation.

## 1.6 Protective Features

This transmitter is equipped with electronic and mechanical safety features. Control signals from other transmitters cannot be processed because transmission coding is unique to each system.

## 1.7 STOP in case of EMERGENCY

Push the emergency stop on the machine.

## 1.8 Caring for your ERGO F21 Transmitter

The enclosure materials used on the ERGO F21 transmitter have been carefully selected to minimise maintenance requirements.



**Always use genuine chargers and accessories.** Cheaper ones that are not compatible or made for going with your ERGO F21 can harm the unit or shorten its lifespan.

Do not keep your ERGO F21 transmitter stored in a closed container for extended periods of time unless it is powered off and the battery is removed from the unit. Charging the battery in a closed container is a potential fire hazard and may shorten its lifespan. Batteries give off heat when charging and when discharging. Keep your battery percentage full charged for longer battery life.



**Clean your transmitter regularly.** Use damp cloth or alcohol wipes to clean the unit's exterior surfaces. Do not use aggressive cleaning agents that may inadvertently damage the unit.

## 2. Introduction and Functional Description

We congratulate you on the purchase of your new Hetronic ERGO F21 transmitter. You have chosen a high quality product. Familiarise yourself with the unit before using it for the first time. In addition please adhere carefully to the operating instructions and the safety advise given in this manual. Only use the product as instructed and only for the intended field of application. Keep this instruction manual in a safe place. If you pass the product on to anyone else, please ensure that you also pass on all the documentation with it.

NOTE: This manual does not cover the Ex version of ERGO F21 transmitters for hazardous explosive environments.

### 2.1 Production and System Numbers

Before contacting your dealer or Hetronic about service, repair or replacement parts, note the equipment Production and System numbers. These numbers are located on the silver label affixed to the unit.

### 2.2 Before Operating Your Wireless Control Unit

Confirm that installation of all your system components has been properly completed. Before start up, **ALWAYS** confirm that the machine and radio remote control Stop functions work properly.

Understand all Safety Precautions provided in the manuals and review control functions and operation of the machine and this radio remote control system. When not in use, turn the transmitter off and store in a safe place to prevent unauthorized use. Ensure that the USB Dongle (which acts as a security key to program the transmitter) is kept in a separate but safe and secure place. If the machine does not respond properly, immediately stop operation. Turn off the transmitter and report the condition to your supervisor.

Turn off the transmitter before any maintenance work is done. Always have fully charged batteries on hand or an optional rechargeable battery pack in the battery charger to ensure the availability of a fully charged battery. Installation, setup and service must be performed by authorized and qualified personnel only.

### 2.3 Unit Labels

#### 2.3.1 Blank Rating Plate

1. Specific approvals, such as CE, FCC, IC, etc.
2. Type: ERGO F21
3. Eleven-digit Production Number
4. Eleven-digit System Number
5. Ingress Protection Rating
6. Frequency information
7. Supply voltage
8. Current rating

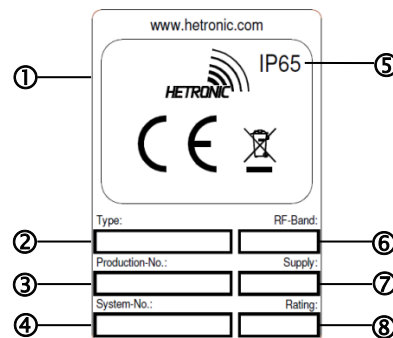

Figure 1. Product Rating Plate

#### 2.3.2 Read User Manual



The "Read User Manual" symbol on the transmitter acts as a reminder for the user to thoroughly read through the manual before attempting to operate the system. This manual must always be placed in a safe and easily accessible place when not being used for when there is the need to refer to it.

## 3. Your ERGO F21 Transmitter

### 3.1 General Description

The ERGO F21 offers an endless array of possibilities from the most basic to complex requirements to satisfy most applications. All transmitters are ergonomically designed, programmable wireless units capable of transmitting a wide variety of functions to remotely control a machine or equipment.

Your transmitter has a rugged IP65 rated housing, is battery-powered, and comes equipped with built-in low battery detection. Standard equipment includes two sets of rechargeable batteries and a battery charger.

### 3.2 ERGO F21 Basic Features

- Fully programmable via Hetric PC-Link
- Ergonomic, reinforced polymer enclosure designed for one-hand operation
- IP65 Rated
- 21 Single Detent Easy-Access Buttons
- 4 Side Buttons for Start, Stop
- Stop Button: Combination STOP/address key cap to store configuration settings
- Half Duplex Communication Mode
- Labelled according to project specification
- Integrated LCD graphics display and up to 21 fully programmable feedback LED's
- Typically 200 m (656 ft.) range using CS4XX and CS8xx modules (Line-of-Sight)
- Typically 50 m (164 ft.) range using CS2400 RF module (Line-of-Sight)
- Internal Antenna
- Auto power off feature (configurable)
- Low Battery detection
- Status bi-colour LED Red/Green
- Multi-Address Mode
- Carry belt or strap
- Rechargeable battery pack

## 4. Product Description

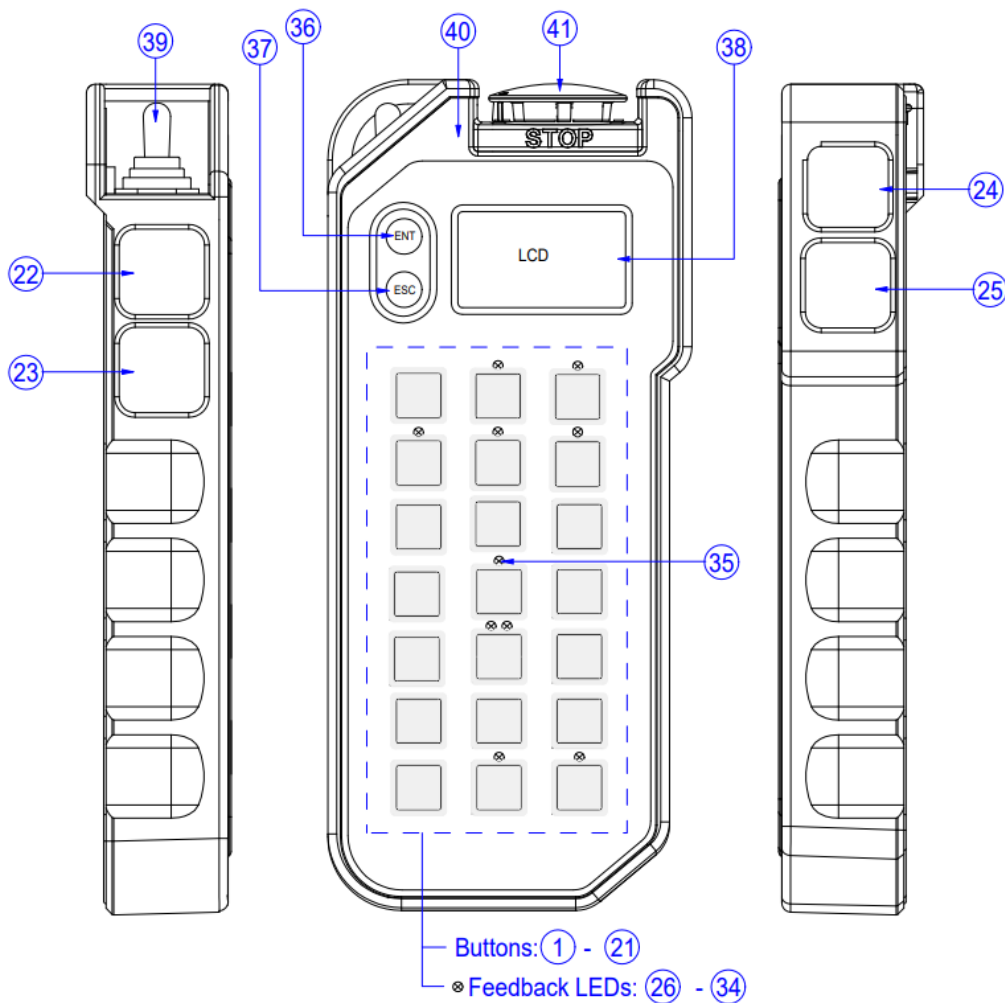

Figure 2. Ergo F21 Transmitter (Left, Front, Right)

1-21	Single Detent Momentary Pushbutton	36	Single Detent Momentary Pushbutton
22	Single Detent Momentary Pushbutton	37	Single Detent Momentary Pushbutton
23	Single Detent Momentary Pushbutton	38	Graphic Display (LCD)
24	Single Detent Momentary START Pushbutton	39	Three Position Maintained Toggle Switch
25	Single Detent Momentary Pushbutton	40	
26-34	Programmable Feedback LEDs	41	Memory Key / STOP Pushbutton
35	Diagnostic LED		

Table 2. Functional Description

Some basic features of the ERGO F21 transmitter are an ON-OFF-ON maintain toggle switch, pushbutton controls, STOP button, LED status and feedback indicators, graphic display and half duplex transceiver.

The graphic display provides real-time visual information during operation of the transmitter. It can be used to change configuration settings, provide two-way feedback and display transmitter diagnostic information such as battery life, signal strength and button status. The status and feedback LEDs are bi-colour (green/red). Feedback LEDs are fully configurable via PC H-Link.



## 5. Operating Your Transmitter

### 5.1 Holding Your Transmitter

Hold the transmitter upright with the front facing you. Confirm that you can easily read and understand any operation text or symbols. Complete the following procedures once a day before the start of an operation and at all shift changes.

### 5.2 Visually Checking Your Transmitter



Always check the transmitter, batteries, and accessories for any physical damage before any operation. Check equipment for wear or damage and confirm that you understand all of the safety labels. Never operate a transmitter with worn-out or damaged parts.

### 5.3 Powering ON and Starting Your Transmitter

NOTE: When the transmitter is not being used by the operator, it must be stored in a safe place.

1. Confirm that all safety measures required by the equipment manufacturer have been followed.
2. Insert a battery adapter with fresh batteries into the battery compartment of the transmitter.
3. Make sure that the **STOP** switch cap is present on the ERGO F21 unit and that no button is pressed.
4. Turn ON the receiver.
5. Press **START** button. The transmitter will perform a routine initialization upon start up.

Note: The Start button is usually on the right-hand side of the transmitter as indicated above with the symbol ■. The power button is usually paired with the horn function ◀. Some units may be configured to have any button start the unit. This is not a default configuration. Units must be programmed using PC H-Link. Consult Hetriconic or your nearest service centre for this feature.

### 5.4 Transmitter Initialization with Standard Status LED Indicator

Upon turning the transmitter ON, all the LEDs light up as solid colours and then the LEDs switch off before the unit performs the routine initialization.

During initialization, if the coder finds an error in the radio module, address, configuration or feedback, the transmitter will boot up and the failure will be displayed as a blinking RED status LED at the baud rate. The transmitter may then be connected to Hetriconic PC-Link for the error to be corrected.

After a successful initialization, the transmitter will enter Normal Operation Mode. The Green LED will blink at the baud rate i.e. the LED toggles on with every transmitted telegram frame. All other LEDs switch off. Test all machine functions. Refer to your machine, transmitter and receiver documentation as needed.

### 5.5 Transmitter Initialization with Graphic User Interface (LCD) and Status LED Indicator

Upon turning the transmitter ON, the LCD screen turns ON and the LEDs light up as solid colours and then switch off before the unit performs the routine initialization.

During initialization, if the coder finds an error in the radio module, address, configuration or feedback, the transmitter will boot up and the failure will be displayed as a blinking RED status LED at the baud rate. The transmitter may then be connected to Hetriconic PC-Link for the error to be corrected.

After a successful initialization, the transmitter will enter Normal Operation Mode and display the software version and the splash screen (if present).

The basic home screen will then be displayed, and the Green LED will also blink at the baud rate i.e. the LED toggles on with every transmitted telegram frame. All other LEDs switch off. Test all machine functions. Refer to your machine, transmitter and receiver documentation as needed.

## 5.6 Stopping the Radio Remote Control

To stop the transmission of data manually, the user must press the **STOP** button.

The text **STOP** appears on the display (if present), the RED status LED blinks at a fast rate and the transmitter sends a Stop telegram to the receiver. Upon receiving the Stop telegram, the receiver goes into Safe Mode and turns OFF all receiver outputs.



If the user wishes to resume operation, this is possible by deactivating the STOP switch and pressing the Start switch again.



**WARNING:** Holding the transmitter improperly while operating your machine could result in unexpected machine response.



**WARNING:** Test the stop function as described in the machine manufacturer's operator manual before beginning any operation.



**WARNING:** To avoid accidental start-up, always press STOP when not in use.

Turn OFF your machine if there is a fault or problem with the safety check.



**NEVER** operate the machine if the STOP function does not work properly.

**WARNING:** Improper operation, maintenance or adjustment may cause serious injury or damage to equipment and may void the warranty.

## 5.7 Battery 'State of Charge' Indication

Unless the transmitter is equipped with a TFT screen, in which case the Battery Level is also displayed on the status bar, the transmitter uses two different warning signs to show the user that the battery needs replacement.

When the Low Battery level warning has been triggered, the RED status LED will blink at a slow rate. The GREEN status LED will still blink at the same rate as the baud rate. The Low Battery detection threshold can be configured through the 'Low Batt Warning' field in the 'RF' tab on Hetricon PC-Link.

In addition to low battery warning, a fixed critical battery level is also monitored. When critical battery level is reached, the RED Status LED will blink faster. The coder will automatically trigger the Stop telegram for about 5 seconds until it shuts off.

## 5.8 LED Behaviour and Meanings

All transmitting units are equipped with LED lights that signal operating status, battery level and fault messages.

State	Meaning
Diagnostic LEDs turn ON	Checking for Memory Key
All LDC segments flash ON and OFF	LCD screen is working
LEDs turn OFF.	Memory Key check is complete
Green LED starts blinking and Settings Screen appears	Transmitter data is being transmitted
NOTE: If the user display is activated, a welcome screen appears, and then the settings screen appears.	
Operation screen appears	Transmitter is operational
NOTE: If Feedback is enabled, feedback status messages also appear on the screen.	

Table 3. LED behaviour explained

## 5.9 Powering OFF the Transmitter

To power OFF the transmitter, the operator must press the STOP switch. It is suggested that the battery is removed from the transmitter when not in use and stored in a safe place to prevent from accidental operation.

The ERFO F21 will also power OFF in the following events:

- 1) Removal of the STOP button cap.
- 2) STOP function is automatically triggered (Passive Stop) due to an error, such as, transmitter out of range.
- 3) When the duration of the Auto-OFF timer has elapsed during which no operational activity has been detected.
- 4) When the battery state of charge is low and the critical battery timer threshold has elapsed.

## 5.10 Belts

The practical belt on the ERGO F21 unit allows the user to clip on the appropriate belt for ease of access and operator safety during operation.

## 6. Generic Radio Remote System functionalities

### 6.1 START Function

The Start button, generally marked in green, is required to initialize radio remote control. For safety reasons, the "Start" command must be given to give the receiver control every time there is an interruption in the control signals. This switch is in many cases paired with the Horn function . In order to start up the radio remote control system from the transmitter one has to make sure the stop button cap must be present and no buttons are pressed.

### 6.2 STOP Function

The most important feature of the radio remote control system is the Stop function. The transmitter sends the Stop status signal along with the rest of the commands through the telegram. This method confirms that ongoing operations are safe. If the Stop pushbutton is pressed (Active STOP), the Stop relay in the receiver causes all functions/motions to stop and the receiver goes into Safe mode.

To restart the system, the Stop button must be present, and the Start/Horn button must be pressed again to close the relays in the receiver and resume function. The Stop functionality responds faster than any other command. When Stop is engaged, the system ignores any other signal that is transmitted. The problem must be corrected before the system will respond to any other signal.

The Stop functionality is self-monitoring and redundant in the transmitter and receiver. The system performs a self-test to ensure the Stop circuit is working properly. If an error is detected, the system automatically goes into Safe mode. When the transmitter is turned on, it performs a self-test to be sure that communications are within designated parameters. If an error is detected, the transmitter will not transmit any signals.

Whenever Safe mode is active without having the STOP button pressed, the system is in Passive STOP. This means that the safety stop relays in the receiver are open so as not to allow any operation. Possible triggers for Passive STOP (Safe Mode) are:

1. Transmitter auto shutdown after period of inactivity
2. Radio signal interference
3. Transmitter out of operating range
4. Low battery sends Stop signal after time out elapses

While it is perfectly protected against unintentional collisions, the STOP button is easily accessible and can be quickly operated with priority.

The STOP button on the transmitter is only a remote stop and will operate only when the transmitter is powered up.



Pressing the STOP pushbutton does not ensure the machine will come to a complete stop. STOP button functionality is subject to the wiring of receiver STOP relays to machine emergency stop circuit and controlled machine logic where applicable.

ALWAYS test the STOP function at the beginning of every operation session or when there is change of operator/shift.

### 6.3 Digital Functions

Digital control (ON-OFF) determines either the opening or closing of a potential-free relay or solid-state switches on the receiver unit installed on the controlled equipment when the operator activates this control.

PC H-Link tool allows one or more and up to three digital control functions to be associated with the same push button switch. This is valid for all single step buttons on the ERGO F21 unit, front panel buttons, the two LCD buttons and also the left and right hand-side buttons.

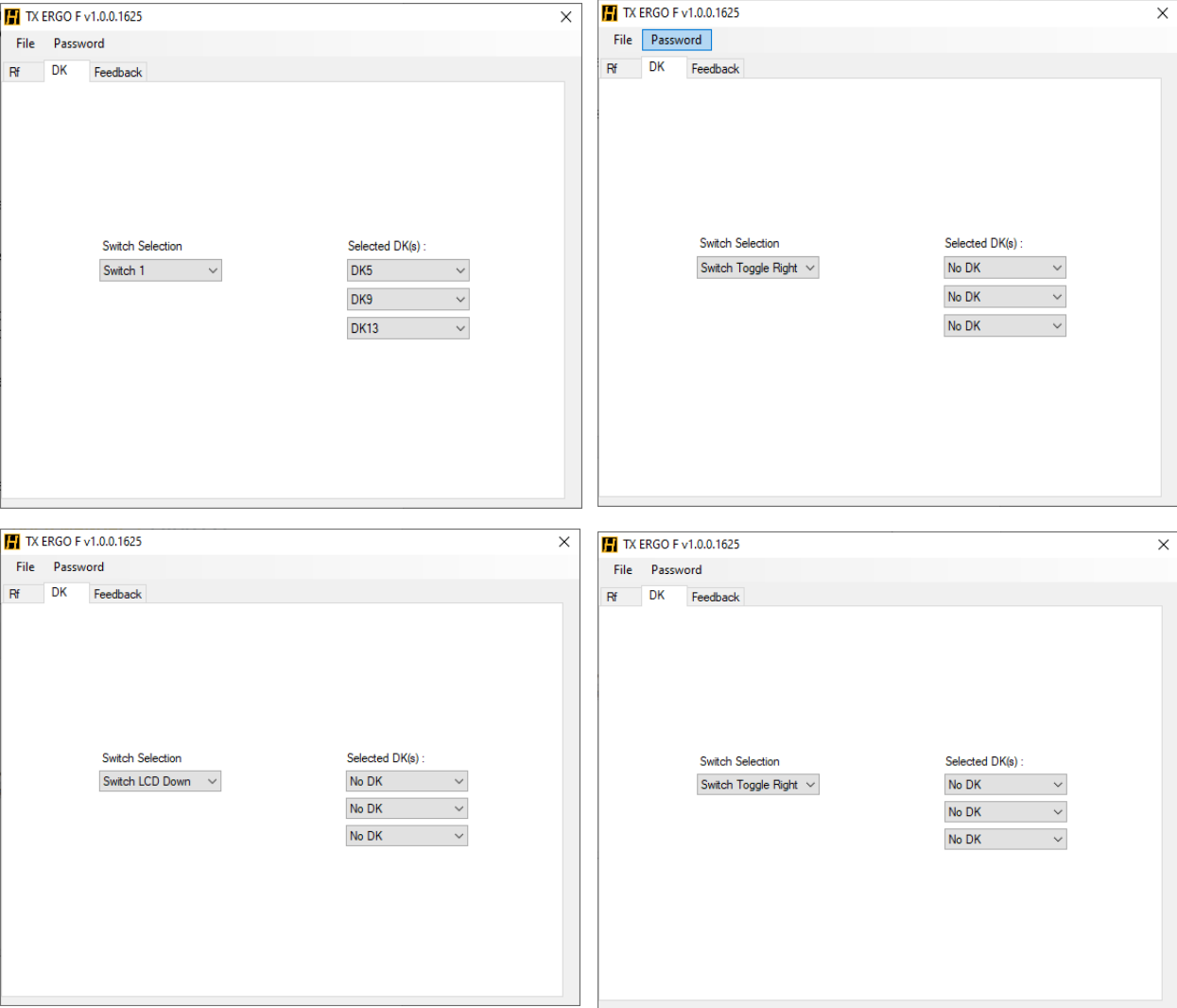

Figure 3. PC H-Link assignment of digital control channels to push buttons

## 7. Setting up your ERGO F21 Transmitter for Operation

### 7.1 Coder

#### 7.1.1 Address Identifier

The unique address identifier with which the ERGO F21 transmitter has been programmed from the factory can be found listed on the product datasheet included with the delivery of the unit. The address is also accessible through RF tab on PC H-Link.

### 7.2 Communication

#### 7.2.1 Radio Settings

The Ergo F21 coder is designed with the possibility to connect one radio frequency (RF) module operating in the sub 1GHz range or 2.4GHz. When the radio module is plugged directly on to the coder (onboard), the user may select the frequency channel or group to use for communication. Different radio modules are required when using CS480TR, CS1200TR and CS2400TR radio modules. Possible bit rates are 2400, 4800 and 9600bps.

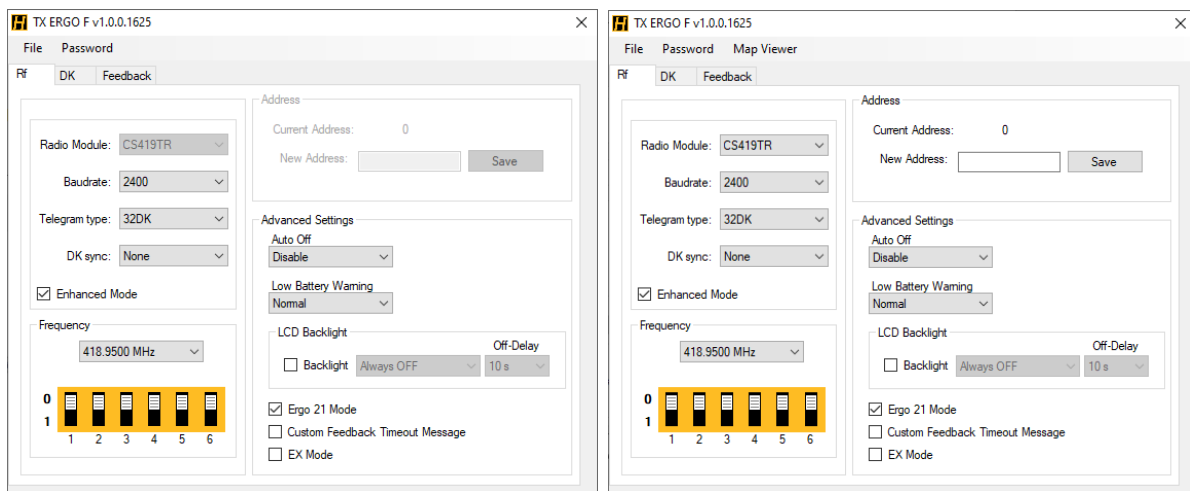

Figure 4. PC H-Link configuration of radio frequency band, frequency channels and bit rate

#### 7.2.2 Auto-OFF

A transmitter Auto-OFF timer can be configured using PC H-Link tool. This feature powers down the unit if it remains idle for a configured period of time, without any of the control buttons being activated. Once a button is activated, the timer is reset. The Auto-OFF timer can also be disabled so that the unit remains always ON until either switched OFF manually or else when the critical battery voltage level is reached, forcing the unit to turn off automatically.

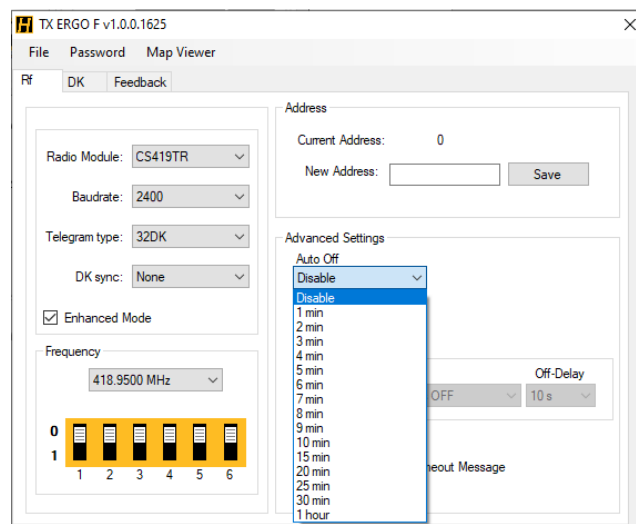

Figure 5. Auto off time configuration options

### 7.3 DK Telegram

There are 32DK switch assignments on the coder board. The definition of the DK control telegram is based on the Hetricon PC-Link configuration which is a logic combination of Input Signal/s and its corresponding DK switch for telegram DK1-DK32.

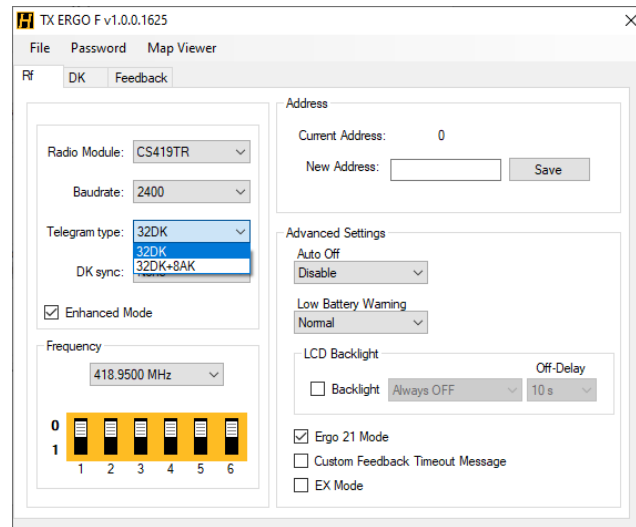

Figure 6. 32DK telegram assignment as default configuration

### 7.4 LCD Backlight

The LCD backlight can be enabled or disabled through PC H-Link tool. The option works only on ERGO F21 units equipped with an LCD. It is also possible to associate one or more digital function with the backlight trigger such that the LCD backlight will turn on whenever the digital signal corresponding to the pressed button is activated. Similarly, the four feedback LED signals can be used independently as backlight triggers. An off delay can also be configured such that the backlight turns off automatically after the pre-configured time is elapsed.

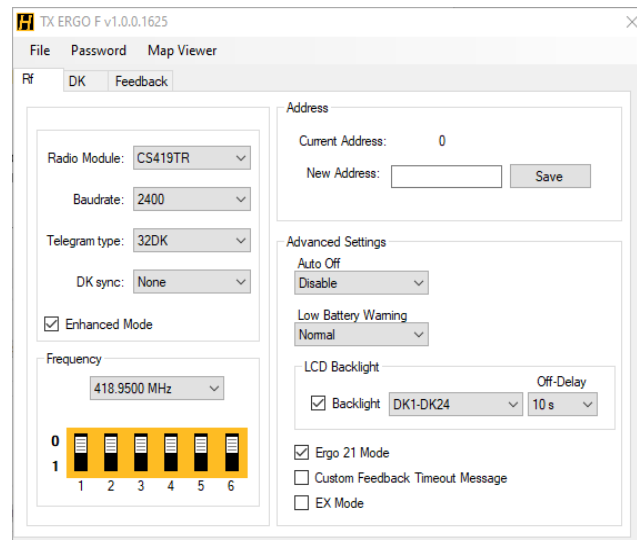

Figure 7. Backlight configuration options

### 7.5 LCD Welcome Note

ERGO F21 units equipped with display offer the product owner to configure a custom welcome note message on the display as part of the power up sequence of the unit. The configuration of the welcome note is possible through the Feedback tab on PC H-Link configurator. The welcome note can be presented as four lines of text of 20 characters each or a 70x32pixel graphic.

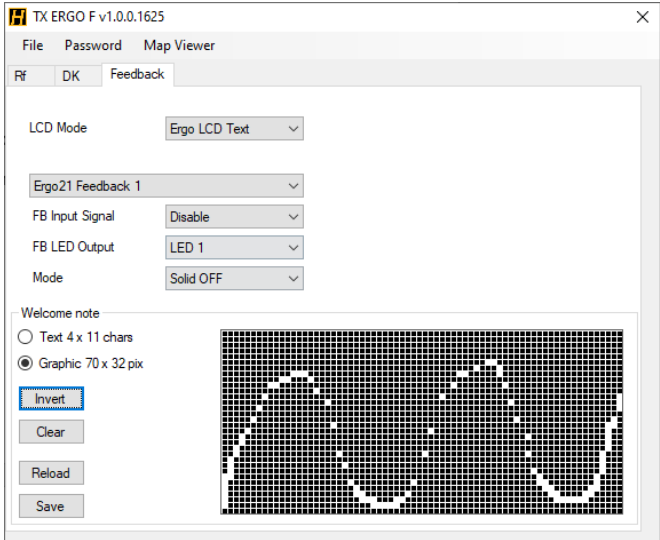

Figure 8. Welcome note graphic configurator

### 7.6 LCD and LED Feedback

ERGO F21 units equipped with display offer the facility of feedback information from the controlled equipment to reach the end-user wirelessly. Three feedback modes are possible on ERGO F21.

#### 7.6.1 ERGO LCD 4-bit

4-bit feedback allows up to 9 alpha-numeric characters to be displayed on the screen for each status of the 4-bit feedback input signals. Refer to the corresponding Hetronic receiver manual for additional information on how to address 4-bit LCD feedback.

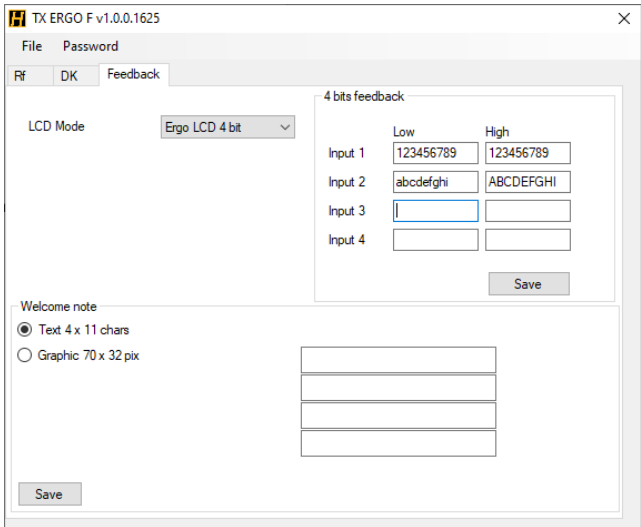

Figure 9. 4-bit LCD feedback configuration



### 7.6.2 ERGO LCD Text

Up to four lines with 20 characters on each can be shown on the display using this feedback mode. Refer to the corresponding Hetricon receiver manual for additional information on how to address LCD text feedback.

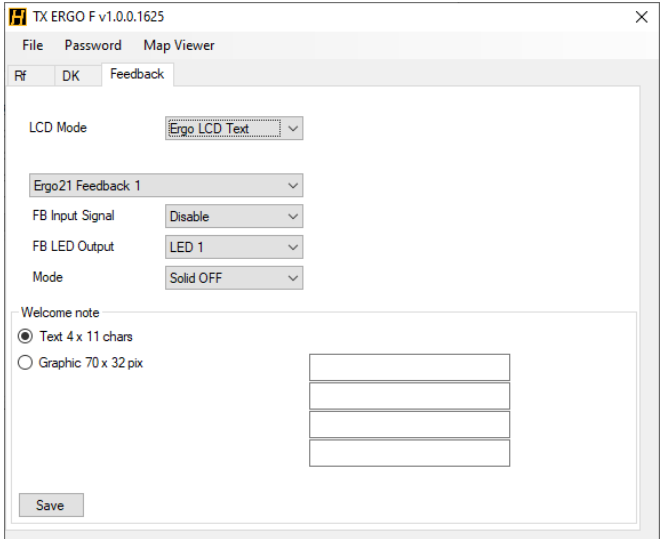

Figure 10. LCD Text mode

### 7.6.3 ERGO Standard

It is also possible to set the LCD feedback mode to standard. This mode allows graphic configuration using LCDxA PC H-Link library. Consult Hetricon or your nearest Hetricon dealer for a copy of this library or additional information.

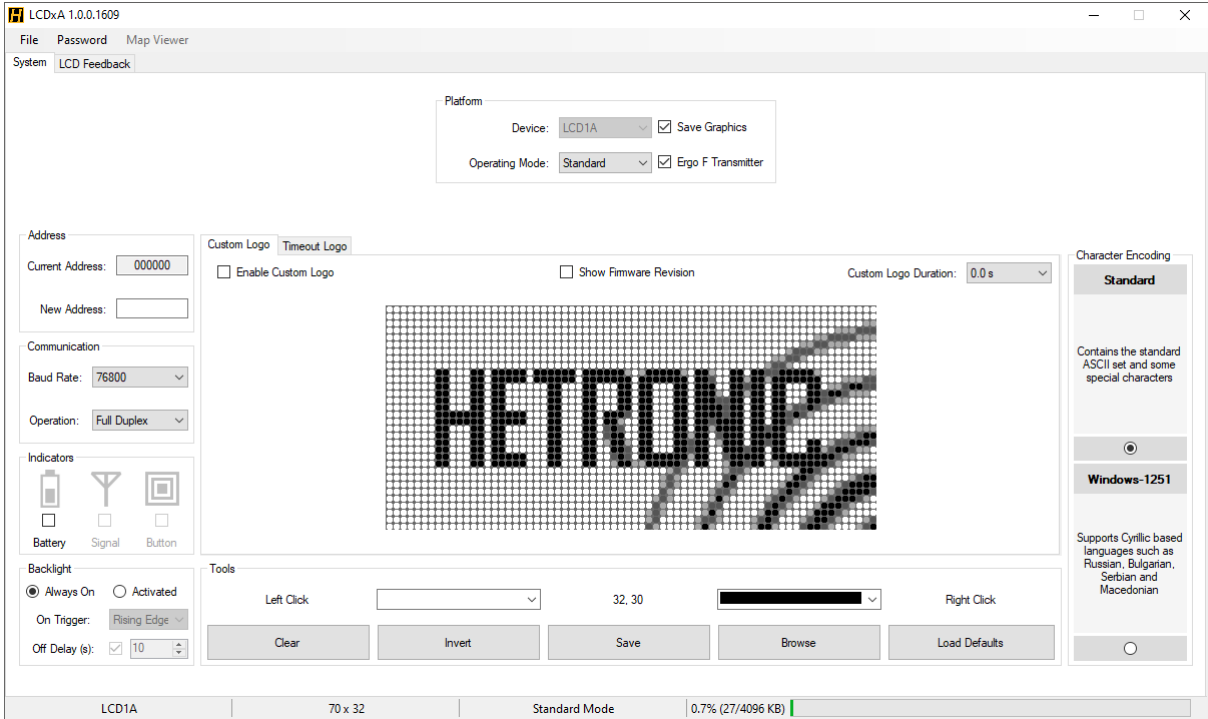

Figure 11. Standard Graphic display programming mode using PC H-Link LCDxA library

7.6.4 LED Feedback

ERGO F21 allows programming of up to 10 feedback LEDs on the front panel. The configuration of LEDs and their ON/OFF/Blink pattern can be adjusted through the Feedback tab on PC H-Link configurator tool. It is also possible to configure each feedback LED with a slow or fast blink behaviour independently.

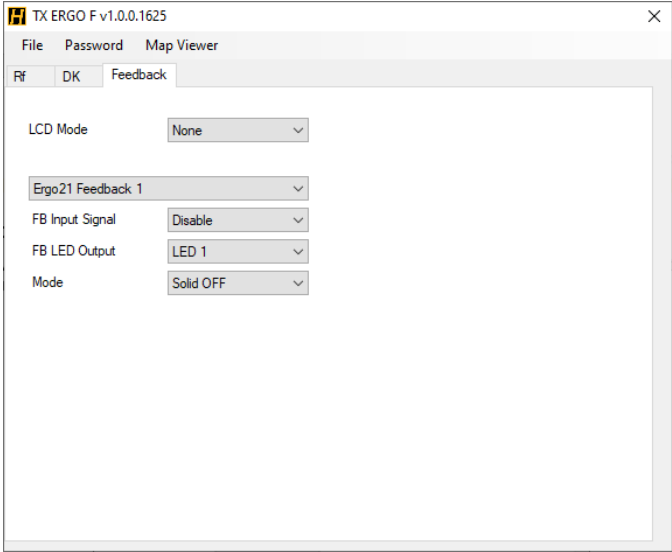

Figure 12. LED feedback configuration

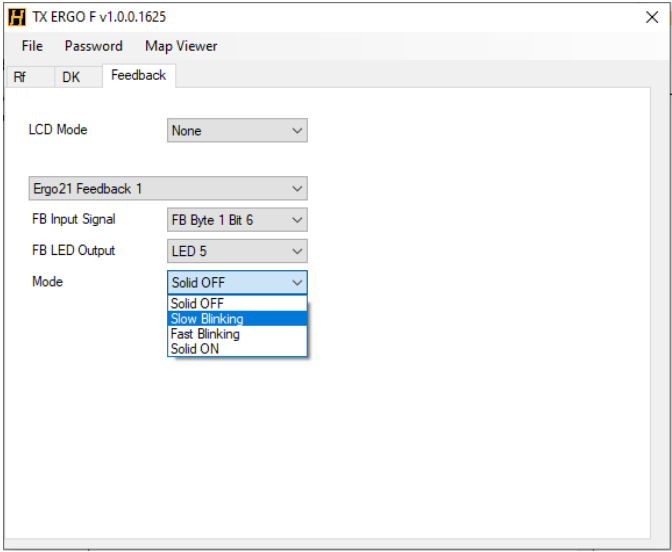

Figure 13. Feedback LED status configuration options

## 8. Theory of Operation

Your ERGO F21 transmitter works with a receiving device to transfer machine control commands via radio frequency to your machine. The transmitter electronically generates a carrier frequency that allows it to communicate with the receiver without the use of cables or wires. The receiver then converts the carrier frequency information into discrete machine control outputs that interface with your machine's controls. Each transmitter and receiver that comprises a system is programmed with a unique address code. The receiver only accepts commands from the transmitter with the same address code. This code ensures that machine operations are safe, and that other remote-control equipment cannot unintentionally control your machine. The receiver and transmitter have the unique address code set at the factory.

## 9. Installing the Radio Remote Control

The following instructions are recommended so as to set up a properly operating radio remote control system. The radio remote control must be installed by qualified personnel only.

Install the receiving unit's antenna in the line of sight of the transmitting unit, without any electromagnetic shielding and away from any metal surfaces for best transmission range.

Do not bypass the safety instructions outlined by the equipment's manufacturer.

Do not install the receiver unit too high above the ground as the unit may receive local radio signals that could disturb transceiver operations.

To prevent water infiltrations, install the receiving unit vertically, with any cable clamps and any other connections at the bottom.

In case of strong mechanical vibrations, rubber shock-absorbing buffers may be installed between the machine and the receiver.

# 10. Troubleshooting

If your ERGO F21 transmitter does not operate after normal start-up, follow the recommended troubleshooting sequence below to help isolate the cause and determine corrective action. If you need more information, contact your nearest Hetronic dealer.

PROBLEM	PROBABLE CAUSE	CORRECTION
Transmitter won't start	Incorrect Access code(if enabled)	Enter correct access code
	Battery fully discharged	Replace with fully charged battery if needed
The transmitter is turned on, but does not transmit (Power LED not flashing)	Battery is discharged	Replace battery with a fully charged battery
	Component failure	Contact your supervisor or nearest Hetronic Service Centre
Transmitter is transmitting (Power LED flashing), but machine will not respond	No power to the receiver	Check the diagnostic LEDs in the receiver to be sure power is applied. Ensure that the system is properly grounded
	Transmitter/receiver frequency channels do not match	Follow instructions under "Setting Frequency and channels" or contact your supervisor
	Transmitter out of range	Take the transmitter back into the range of the receiver, press START
	Receiver powered off	Turn on power to receiver
	Blown fuse in receiver	Check all fuses and replace if needed
	STOP failure in receiver. Red STOP LED on PC board is illuminated	Contact your supervisor
Battery Status is not displayed	I2C connector inside transmitter is loose	Check all connectors, reseal if needed
All machine motions operate intermittently	Receiver antenna connection is loose or missing	Tighten or replace antenna
	External antenna (if used) has loose connection, poor grounding or interference	Tighten antenna and ground connection. Contact Hetronic or your Dealer for more information
	Connector inside receiver is loose	Check all connectors, reseal if needed
	Another frequency may be interfering with the system	Contact your supervisor

**Table 2.** Troubleshooting tips

# 11. Warranty, Service, Repairs and Maintenance

Before any service or maintenance intervention on remote controlled equipment always:

- Remove all electrical power from the equipment
- Follow lock out procedures

Hetronic products are covered by a guarantee/warranty against material, construction and manufacturing faults. During the guarantee/warranty period, Hetronic may replace the product or faulty parts. Work under guarantee/warranty must be carried out by Hetronic, or by an authorized service centre specified by Hetronic. Any modification, reconstruction or extension of the systems without a written agreement of Hetronic may lead to the loss of your warranty and guarantee claims.

The following are **not** covered by the guarantee/warranty:

- Faults resulting from normal wear and tear
- Consumables e.g. batteries
- Products that have been subject to unauthorized modifications
- Faults resulting from incorrect installation and use

## **Maintenance and Preventive Care**

- Repairs and maintenance must be carried out by qualified personnel
- Only use original Hetronic spare parts
- Contact your representative for service or any other assistance
- Keep the product in a clean, dry place
- Keep battery contacts clean
- Wipe off dust using a slightly damp, clean cloth
- Remove dust from inside gaps, docking recesses and battery contacts using a vacuum. Special care must be taken when cleaning the battery compartment of the transmitter as detachment of the pressure balance element may lead to ingress protection problems

## **NEVER USE:**

- Abrasive cleaning solutions or high-pressure water jets.
- Sharp, pointed objects or any hard items as these may tear the rubber parts.
- Compressed air as this may lead to ingress protection issues.
- Petroleum based solvents including Diesel and Gasoline to clean the unit as these may react with the silicone rubber of the joystick gaiter.

Note: Refer to web shop for items available as spare parts.

# 12. Regulatory Information

## 12.1 Europe

### CE Marking

Transmitter - Hetronic hereby declares that the safety component "Radio Remote Control Transmitter Type ERGO F21" covered by this manual is in compliance with Directive 2006/42/EU article 2(c) and is designed for installation on machinery or other devices. Furthermore, the listed safety component meets the following relevant directives at the time of delivery from the Hetronic manufacturing facilities:

Machinery Directive	2006/42/EU
RED Directive	2014/53/EU

Batteries - Hetronic declares that the components listed as "Rechargeable Battery Type MINI NiMH" are in accordance with all provisions of Annex I of the EU Council Directive 2014/30/EU referred to as EMC Directive.

Chargers - Hetronic declares that the "Battery Charger UCH 2" is in accordance with 2006/42/EU article 2(c), are is designed for installation on machinery or other devices. Further, the above listed safety components meet the following directives at the time of delivery from the Hetronic manufacturing facilities:

Machinery Directive	2006/42/EU
---------------------	------------

The latest version of the complete EU Declarations of Conformity for the ERGO F21 Transmitter, MINI Battery and UCH-2 charger are available on the Hetronic website [www.hetronic.com](http://www.hetronic.com).

### WEEE Directive



This symbol means that inoperative electrical and electronic products must not be mixed with household waste. The European Union has implemented collection and recycling system for which producers are responsible. For proper treatment, recovery and recycling, please dispose of the product in a designated collection point.



### REACH Compliance

Hetronic confirms that, to the best of its knowledge and continual communication with its respective suppliers, chemical Substances of Very High Concern (SVHC) are not included in our products. Based on the response statements of our suppliers no materials from the ECHA are included on Hetronic products. For the latest version of the complete Declaration of Conformity please visit the Hetronic website [www.hetronic.com](http://www.hetronic.com).

### RoHS Compliance

As a designer and manufacturer of electrical and electronic products covered by RoHS, RoHS2 and RoHS3, Hetronic confirms that to the best of its knowledge at the date of this statement, none of the products supplied by it contain any of the hazardous substances in excess of permitted levels referred to in the Directive 2002/95/EC. The latest version of the complete Declaration of Conformity is available on the Hetronic website [www.hetronic.com](http://www.hetronic.com)

## 12.2 North America

### California Proposition 65

As a designer and manufacturer of electrical and electronic products, Hetronic confirms that to the best of its knowledge at the date of this statement, none of the products supplied by it contain any of the hazardous chemicals listed on California's Safe Drinking Water & Toxic Enforcement Act of 1986 (commonly known as California Proposition 65).

### FCC Recommendations:

This device complies with Part 15 of the FCC Rules. Operation is subject to the following two conditions:

1. This device may not cause harmful interference, and
2. This device must accept any interference received, including interference that may cause undesired operation.

Changes or modifications not expressly approved by the manufacturer could void the user's authority to operate the equipment.

To comply with FCC RF exposure compliance requirements, this device and its antenna must not be co-located with, or operating in conjunction with, any other antenna or transmitter.

This equipment has been tested and found to comply with the limits for a Class B digital device, pursuant to Part 15 of the FCC Rules. These limits are designed to provide reasonable protection against harmful interference when the equipment is operated in a residential environment.

This equipment generates, uses, and can radiate radio frequency energy and, if not installed and used in accordance with the instructions, may cause harmful interference to radio communications. However, there is no guarantee that interference will not occur in a particular installation. If this equipment does cause harmful interference to radio or television reception, which can be determined by turning the equipment off and on, the user is encouraged to try to correct the interference by one or more of the following measures:

- Reorient or relocate the receiving antenna
- Increase the separation between the equipment and receiver
- Connect the equipment into an outlet on a circuit different from that to which the receiver is connected.
- Consult the dealer or an experienced radio/TV technician for help.

### **12.3 Industry Canada (IC/ISED) Statement**

#### **IC RF Exposure Statement**

This device meets the IC requirements for RF exposure in public or uncontrolled environments.

#### **IC Warning**

This product complies with Industry Canada's licence-exempt RSS standards. Operation is subject to the following two conditions:

1. This device may not cause interference, and
2. This device must accept any interference, including interference that may cause undesired operation of the device.





[www.hetronic.com](http://www.hetronic.com)



© 2022 Hetronic

All rights reserved. No part of this publication may be reproduced, transmitted, transcribed, stored in a retrieval system, or translated into any language in any form by any means without the written permission of Hetronic.

Technical information subject to change without notice.

Hetronic reserves the right to discontinue, make changes to, and add improvements upon its standard products at any time without public notice or obligation. Hetronic disclaims liability for any claims or damages, whether regarding property, personal injury or death arising out of the use of unauthorized replacement parts or service.

## Appendix A

### Definition of terms

The following terms are used throughout the ERGO F21 User Manual and may be unfamiliar to some operators.

<b>Term</b>	<b>Definition</b>
baud rate	The transmitting speed measured in bits per second.
hamming distance	A measurement of data transmission safety. The amount of failures in the data stream which has to occur during the transmission in order to create a wrong signal.
base address	The base address is the Hetric PC-Link assigned address of the coder

## Appendix B

### B.1 Operator Safety Basics

Before starting your shift, you should make sure that the equipment has a current inspection certificate and that the necessary inspections and risk assessment checks have been carried out and are up to date. Also, the equipment must be operated in accordance with the manufacturer's instructions.

Furthermore, it is of utmost importance that you know that **YOU are primarily responsible for YOUR OWN health and safety**. Wear appropriate Personal Protective Equipment and make sure that you have had all the necessary training to operate the equipment. The following basic safety precautions must be adhered to at all times:

1. Transmitter switches must never be mechanically blocked ON or OFF for any motion. When not in use the transmitter must be turned off. A safe and secure storage space should be provided for the transmitter unit and the unit should always be placed there when not in use. This precaution will prevent unauthorized people from operating the crane. Receivers must be removed from the equipment when it is unlikely that it will be used for a period of time, and properly stored.
2. All defective or missing safety equipment, mechanical or electrical defects must be reported to the supervisor without delay. Operation must not continue until all required repairs are completed. Any changes to the condition of the remote or equipment must be recorded and communicated to or made accessible by the following operators on shift.
3. Ensure that there is nobody in the path of the travel of the equipment. If there is, stop and sound the alarm before proceeding.
4. When leaving the equipment area for any reason, switch off the transmitter, remove the key cap and store it in a safe and secure place to prevent unauthorized operation.
5. Do not allow any unauthorized person to operate the transmitter at any point.
6. Do not operate the transmitter at a distance where the equipment and all surrounding objects are not visible. Make sure that your view is not obstructed.
7. Do not attempt to override any of the safety features built into the Radio Remote Control.
8. Put rechargeable batteries on charge at the end of each shift. Chargers are not intended for outdoor use. Use only indoors.
9. Non-rechargeable batteries must NOT be used to power the transmitters. Use ONLY Hetronic rechargeable batteries.
10. Use protective gloves when surface temperature of unit exceeds 58°C (136°F) as per IEC 62368-1:2014.

### B.2 Safety Checklist

The following checklist provides general safety guidelines for radio control operation of equipment by fully qualified and trained operators. These recommendations do not take precedence over any of the following requirements relating to cranes, hoists, lifting devices or other equipment which use or include Hetronic products:

- Instructions, manuals, and safety warnings of the manufacturers of the equipment where Hetronic products are used,
- Plant safety rules and procedures of the employers and the owners of the facilities where the Hetronic products are being used,
- Occupational Health and Safety Administration (OSHA) regulations,
- Safety standards and practices for the industries in which Hetronic products are used.

<b>Transmitter Start-up and Safety Checklist</b>		
1	Are batteries fully charged?	
2	Are all switch labels clear and legible?	
3	Is the transmitter free from cracks and damages?	
4	Are the battery enclosures free from cracks and damages?	
5	Is the STOP function working as it should be?	
6	Is the correct key cap being used?	
7	Has each function of the transmitter been tested independently to ensure the equipment is responding correctly?	
8	Is the TFT (where applicable) free from cracks, deep scratches and damages?	
9	Are the switches/rubber caps free from damages/tears?	
10	Are the LEDs on the transmitter clearly visible?	
11	Are the charger and plug in good working condition?	
12	Is the cable control cable (where applicable) free from kinks and damages?	

## Transmitter Specifications

Housing:	Ergonomically designed PC-ABS blend housing, one-hand operation
Environmental Protection:	IP 65 (Exceeds Nema 12/13)
Weight:	Up to 400 g (14.2 oz.), including battery
Dimensions:	Height: 186 mm (7.3 in.)
	Width: 82 mm (3.2 in.)
	Depth: 39 mm (1.3 in.)
Antenna:	Internal
Power Supply:	3 AA batteries (3 Mignon LR6-AA 1.5V)
	Optional 3.6V 2.75Ah NiMH rechargeable battery
Diagnostics:	Status LED for operation and standard/advanced low battery detection
Transmission icon	Battery usage icon
	Push button activation icon
Operation Time:	Up to 20 h continuous transmission
Control Configuration:	25 Single detent push buttons, 1 three position maintained toggle switch, start + stop
Frequency Range:	419 MHz, 429 MHz, 434 MHz, 447 MHz, 458 MHz, 480 MHz, 8xx MHz (FH), 9xx MHz (FH), 2.4GHz (MFS or FH)
RF Unit:	Type CS synthesized with programmable frequencies
Power (RF Output):	< 10mW for non-frequency hopping versions < 10mW for 2.4GHz Multiple Frequency Selection version < 25mW for 8xx and 9xx frequency hopping versions < 100mW for 2.4GHz frequency hopping versions
Typical Operating Range:	~50 m. (328 ft.) for 2.4Ghz MFS ~200m for 4xx, 8xx, 9xx and 2.4GHz FH versions
Safety:	20-bit programmable address concept with up to 1,000,000 combinations
	Hamming Distance 3
Temperature Range:	-25 to +70 degrees C (-11 to +158 degrees F)
Humidity Range:	0 - 97% maximum non-condensing
Response Time:	< 100 msec.
Baud Rate:	Up to 9600 bps for non 2.4GHz versions Up to 50000 bps for 8xx and 9xx FH versions Up to 115200 bps for 2.4Ghz FH version
Standard Features:	Fully programmable using PC H-Link tool & USB dongle7
	Integrated LCD graphics display with feedback capability
	Combination stop/Memory Key cap that stores configuration settings
	Push button monitoring
	Hand and wrist strap

## Battery & Charger

You may power your transmitter with disposable or rechargeable batteries. Both types use adapter cases that are inserted into the back of the transmitter.

Follow the instructions below for your battery type.

### DISPOSABLE BATTERIES:

1. Insert 3 AA batteries into the back of the Standard Battery Adapter Case.

NOTE: Battery positions are shown in the battery slots on the back of the Battery Adapter Case housing.

2. Slide the loaded Battery Adapter Case into the battery compartment on the back of the transmitter housing and snap into place.

### RECHARGEABLE BATTERIES:

1. Confirm that your batteries are fully-charged.
2. Slide the recharged battery into the battery compartment on the back of the transmitter as shown, and snap it into place.

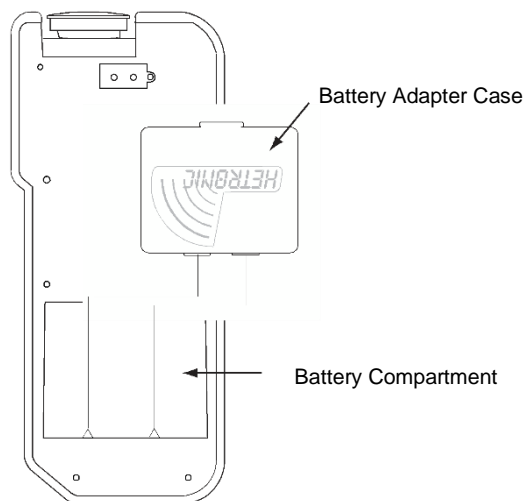

Figure 14. Inserting Battery

## Accessories and Spare Parts

The standard carrying accessories for the ERGO F 21 transmitter are the belt and hand strap.

Refer to the online web shop for respective part numbers of any other parts that may need replacement:

<https://shop.hetronic.com/mt/en/home>

**NOTE:** Any service/maintenance work and replacement of parts must be carried out by an authorized dealer or service centre specified by Hetronic.

**NOTE:** Keep the safety instructions for future reference. Always download the User Manual instructions from our website for the latest version available.

## Battery Types and Specifications

### Battery MINI 3.6V/2.75Ah Grey NiMH

Item No. 68301000

Battery MINI 3.6V 2.75Ah	
Rated Capacity	3.6V 2.75Ah NiMH rechargeable battery pack
Storage Environment Conditions	-20°C . . . 40°C, 85%RH max (for short periods less than 1 month) -20°C . . . 30°C, 85%RH max (for periods less than 3 months) -20°C . . . 20°C, 85%RH max (for long term storage, max 1 year)
Charging Temperature Range	0°C . . . 40°C (32°F . . . 104°F), max 85%RH
Discharging Temperature Range	-10°C . . . 55°C (14°F . . . 131°F) , max 85%RH
Charging Time (hrs)	14 (0.1 CmA)

**Table 4** 3.6V 2.75Ah MINI Battery Technical Specification



**Figure 15.** 3.6V 2.75Ah NiMH Battery

### Battery Disposal

AVOID ENVIRONMENTAL POLLUTION. Recycle your rechargeable batteries according to local recycling rules and regulations. If you have questions or problems operating your battery charger, please contact your nearest Hetronic dealer or service centre.

Standard Hetronic rechargeable batteries are the Lithium-Ion type. These batteries have no “memory effect” when charging a battery that is not fully discharged.

### Prolonged Battery Life

Avoid battery misuse, over charging, overheating or regular dropping. This can cause permanent damage to the cells.

It is recommended that the battery is not used at temperatures exceeding 60°C for a prolonged time since this will shorten the battery lifetime by approximately 15%.



Never keep a fully charged battery at elevated temperatures. Battery pack does not die suddenly but the runtime gradually shortens as the capacity fades.



Keeping the charge in the 40% to 80% range will prolong battery life.

Unfortunately there is no avoiding fact that battery has a finite life, after which they will certainly degrade. Following these basic tips can help delay the inevitable.

## MINI UCH 2 Battery Charger

### Recharging your Batteries

To charge the MINI battery, it must be removed from the transmitter by lifting it up and sliding it out of the battery compartment. Slide the battery in the charging unit until it clips in place and the yellow 'CHARGE' LED flashes for two seconds. The yellow LED will remain ON for the whole charging process. When the battery is fully charged, the "READY" green LED lights up and the "CHARGE" yellow LED goes off.

NOTE: If the yellow LED continues to blink after 2 seconds of inserting the battery in the charger, then the battery is defective and must be replaced.

A switch on the indicator panel initiates fast charging of the battery. When "Fast Charge" is in progress a red LED turns on together with the yellow "CHARGE" LED. When fast charging is complete, the green "READY" LED lights up and the red LED switches off.



Charging the MINI Battery

Leave the battery in the charger until it is needed. The charger supplies a "trickle" charge but it will not over-charge the battery.

The charger power cable is supplied with different plugging options: EU plug, cigarette lighter plug, US plug, etc. Below is the list of the variants available.



Figure 16. Charger plug variations



Reference ID	Item Number	Description
A	68108570	Charger Mini 90-270VAC 300/780mA Euro-Plug with Fast Charge
B	68108690	Charger Mini 10-30VDC 300/780mA Plug Cigarette Lighter with Fast Charge
C	68108580	Charger MINI 90-270VAC 300/780mA UL-Plug with Fast Charge
D	68108595	Charger Mini 90-270VAC 300/780mA Australia/N.Z. Plug with Fast Charge
E	68108670	Charger Mini 10-30VDC 300/780mA Sliding Socket with Fast Charge
F	68108560	Charger Mini 90-270VAC 300/780mA UK-Plug with Fast Charge

*List of UCH 2 Charger Variants*



EXPLOSIVE GASES AND FLYING DEBRIS can cause death or serious injury. Use only Hetric replacement rechargeable batteries. Use of unauthorized replacement batteries could cause a battery explosion resulting in injury or death of the operator or other people in the work area.