

ERGO 120

USER OPERATION AND SERVICE MANUAL

08/2018

www.hetronic.com

Table of Contents

1. Safety	3
1.1 Intended Use	3
1.2 Symbol Notation	3
1.3 Practices and Laws	3
1.4 Required Operator Training	3
1.5 Possible Sources of Danger	3
1.6 Protective Features	4
1.7 STOP in case of EMERGENCY	4
1.8 Caring for your ERGO 120.....	4
2. Introduction and Functional Description	5
2.1 Production and System Numbers	5
2.2 Before Operating Your Wireless Control Unit.....	5
2.3 Unit Label Areas and Meanings	5
3. Your Ergo 120 Transmitter.....	6
3.1 General Description	6
3.2 Ergo 120 Features.....	6
3.3 Ergo 120 Programming.....	6
3.4 Standard Ergo 120 2.4GHz Configuration.....	6
4. Theory of Operation.....	12
4.1 Stop Function	12
5. Changing the battery	13
5.1 Recharging your Batteries	14
5.2 Battery Disposal	14
5.3 Prolonged Battery Life	14
6. Operating Your Transmitter	15
6.1 Holding Your Transmitter	15
6.2 Visually Checking Your Transmitter	15
6.3 Powering Up and Starting Your Transmitter.....	15
6.4 Stopping Radio Remote Control	16
7. Troubleshooting.....	17
8. Specifications	18
9. Warranty, Service, Repairs and Maintenance	19
10. Regulatory Information	20

List of Figures

Figure 1. Rating Plate.....	5
Figure 2. Ergo 120 Transmitter (Right, Front, Left)	7
Figure 3. Ergo 120 Transmitter.....	12
Figure 4. Inserting Battery	13
Figure 5. Battery Insertion in Charger.....	14

List of Tables

Table 1. Ergo 120 Transmitter features	7
Table 2. Analog configuration parameters.....	8
Table 3. Radio parameters.....	9
Table 4. LED behaviour and Meanings	15
Table 5. Troubleshooting tips.....	17
Table 6. Technical Specification.....	18

1. Safety

1.1 Intended Use

Your radio remote control is designed for remote operation of machines and systems using safe wireless communications technology.

Hetronic assumes no liability for damages resulting out of the non-observance of this operating manual. All persons, working with this radio remote control must



- Be suitably trained and qualified as required by the safety regulations.
- Strictly comply with the contents of this operating manual.

Before starting the radio remote control you must have read and fully understood this operating manual.

1.2 Symbol Notation

The following symbols are used in this operating manual. The safety alert symbol is used in decals on the unit and with proper operation procedures in this manual.

Understand the safety message. It contains important information about personal safety on or near the unit.

	STOP! This symbol gives you warning of imminent danger of life, risk of accident and risk of injury, as well as damage to property in case of non-observance of the working instructions.
	ATTENTION! This symbol advises against a possible damage to the system in case of non-observance of the working instructions.
	TIP! This symbol points to features and information which allow for an easier handling or operation.

1.3 Practices and Laws

Practice safe working precautions for the benefit of yourself and others.

Be alert to unsafe conditions and the possibility of minor, moderate, or serious injury or death. Learn applicable rules and laws in your area.

1.4 Required Operator Training

The original purchaser of this unit was instructed by the seller on safe and proper operation. If unit is to be used by someone other than original purchaser; loaned, rented or sold, ALWAYS provide this manual and any needed safety training before operation. ALWAYS read and understand the documentation for any machine to be controlled by radio remote control.

1.5 Possible Sources of Danger

This device is part of a system that makes remote control via wireless radio signals possible. The transmission of control commands can take place around obstacles and out of the operator's direct line of sight. Take the following precautions to prevent accidental start-up and possible injury or damage:



Switch "OFF" the transmitter when it is not in use. Unless the transmitter has user access control password configured, remove the battery if unit is placed away from the operator.



Disconnect the power supply from the receiver before any assembly, maintenance or repair work is done.



AVOID SYSTEM DAMAGE - ALWAYS disconnect receiver power supply and control wiring before welding on any part of the machine.



Never remove or alter any of the safety features.



ALWAYS confirm that the machine and radio remote control Stop functions work properly **BEFORE** beginning any machine operation.

1.6 Protective Features

This transmitter is equipped with electronic and mechanical safety features. Control signals from other transmitters cannot be processed because transmission coding is unique to each system.

1.7 STOP in case of EMERGENCY

Push the emergency stop on the machine.

1.8 Caring for your ERGO 120

The enclosure materials employed on the ERGO 120 transmitter have been carefully selected to minimise maintenance requirements.



Buy a Hetricon Ergo 120 holster and screen protector. These will take care of your transmitter by preventing it from being subject to knocks and scratches. This helps to keep the unit's appearance longer and may also protect it from some internal damage should you accidentally knock or drop it.



Always use genuine chargers and accessories. Cheaper ones that are not compatible or made for going with your ERGO 120 can harm the unit or lessen its lifespan.

Do not keep your ERGO 120 stored in a closed container for extended periods of time unless it is powered off. Charging the ERGO 120 in a closed container is a potential fire hazard and may shorten its lifespan. Li-Polymer batteries give off heat when charged and when discharging. Keep your battery percentage between 40%-80% for longer battery life.



Clean your ERGO 120 regularly. Use damp cloth or alcohol wipes to clean the unit's exterior surfaces. Do not use aggressive cleaning agents that may inadvertently damage the unit.

2. Introduction and Functional Description

We congratulate you on the purchase of your new Hetronic ERGO 120 push button transmitter. You have chosen a high quality product. Familiarise yourself with the unit before using it for the first time. In addition please carefully refer to the operating instructions and the safety advise given in this manual. Only use the product as instructed and only for the intended field of application. Keep these instructions in a safe place. If you pass the product on to anyone else, please ensure that you also pass on all the documentation with it.

2.1 Production and System Numbers

Before contacting your dealer or Hetronic about service, repair or replacement parts, note the equipment Production and System numbers. These numbers are located on the silver label affixed to the unit.

2.2 Before Operating Your Wireless Control Unit

Confirm that installation of all your system components has been properly completed. Before start up, **ALWAYS** confirm that the machine and radio remote control Stop functions work properly.

Understand all Safety Precautions provided in the manuals and review control functions and operation of the machine and this radio remote control system. When not in use, turn the transmitter off and store in a safe place to prevent unauthorized use. If the machine does not respond properly, immediately stop operation. Turn off the transmitter and report the condition to your supervisor.

Turn off the transmitter before any maintenance work is done. Always have fresh batteries on hand or an optional rechargeable battery pack in the battery charger to ensure the availability of a fully charged battery. Installation, setup and service must be performed by authorized and qualified personnel only.

2.3 Unit Label Areas and Meanings

- 1. Specific approvals, such as CE, FCC, IC, etc.
- 2. Type of ERGO 120 transmitter
- 3. Frequency information
- 4. Supply voltage
- 5. Current rating
- 6. Eleven-digit Production Number
- 7. Eleven-digit System Number

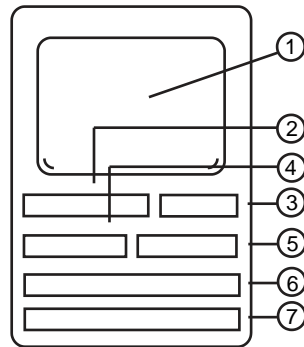

Figure 1. Rating Plate

3. Your Ergo 120 Transmitter

3.1 General Description

The Ergo 120 is an Ergonomically designed, programmable wireless transmitter capable of transmitting up to 32 on/off functions to remotely control a machine.

Your transmitter is encased in a rugged IP65 rated housing, is battery-powered, and comes equipped with built-in low battery detection. Standard equipment includes two 3.2Ah Lithium polymer batteries and battery charger equipped with different AC power adapters for different countries for your convenience.

3.2 Ergo 120 Features

- Fully programmable via H-Link
- 10 push buttons with up to two detents
- 4 push buttons with up to two detents
- 2 proportional push buttons*¹
- Up to 100 m (300 ft.) range using CS419, CS429, CS434, CS447 and CS458 RF modules
- Up to 60 m (196 ft.) range using CS2400 RF module
- Up to 50 m (164 ft.) range using on board MFS radio
- Internal Antenna
- Auto power off feature
- Infrared
- USB Interface
- Tilt Sensor
- Low Battery detection
- Diagnostic LED
- Cable Control
- Belt Clip
- Holster

Note: *1: Proportional push buttons are only available as an option on two top left and right side switches.

3.3 Ergo 120 Programming

Ergo 120 units can be configured wirelessly using Hetric's PC H-Link programming tool without being opened!

PC H-Link can access and set functions such as system address, transmission frequency channel, auto shut-off features, switch DK assignments, device status and much more. Refer to the Ergo 120 configuration – Transmitter mode Section for more information.

3.4 Standard Ergo 120 2.4GHz Configuration

3.4.1 Transmitter version

The Ergo 120 2.4GHz transmitter is factory programmed to one of the following configurations:

A. Ergo 120 2.4GHz-V1

- 14 Single detent pushbutton
- 1 Single detent START pushbutton

B. Ergo 120 2.4 GHz-V2

- 4 Single detent pushbuttons
- 10 Double detent pushbuttons
- 1 Single detent START pushbutton

C. Ergo 120 2.4 GHz-Prop

- 2 Proportional pushbuttons
- 10 Single detent pushbuttons
- 1 Single detent START pushbutton

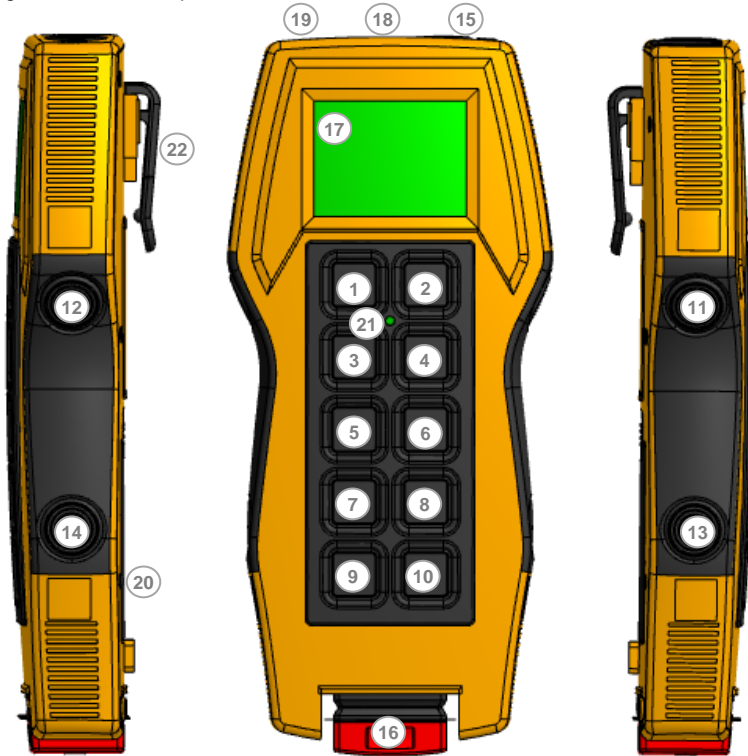

Figure 2. Ergo 120 Transmitter (Right, Front, Left)

1-10	Up to 2 Detent Momentary Pushbutton (S1-S10)
11-15	Single Detent Momentary Pushbutton (S11-S15)
16	STOP Pushbutton (S16)
17	TFT Display (if equipped)
18	Infra Red
19	USB port
20	Battery Compartment (located at the back)
21	Diagnostic LED
22	Belt Clip

Table 1. Ergo 120 Transmitter features

3.4.2 Transmitter Mode

Your Ergo 120 transmitter has the following modes:

1. Operational Mode: In this mode your Ergo 120 transmits and receives (if enabled in Hetricon PC H-Link software) the data according to the factory configuration. This can be changed by loading the configuration through PC H-Link. Your Ergo 120 enters into operation mode only if the ACCESS CODE is entered correctly by the user if this is enabled. (This can be configured through PC H-Link, user control tab)

2. Service Mode: Your Ergo 120 transmitter's parameters (Frequency, Baud rate, display brightness, access code, time, date and much more) can be updated without connecting to H-Link. This mode is activated by holding the upper side switches or Lower side (S11 & S12/SW13 & SW14) and then turning your Ergo 120 transmitter ON. In this mode the user can also check proper functioning of the buttons.

3. Boot loader Mode: Your Ergo 120 transmitter can be easily updated to latest firmware by going into boot loader mode. This mode is activated by holding lower side switches (S13 & S14) and connecting the USB while STOP switch (S16) is active.

4. H-Link Mode: Your Ergo 120 transmitter connects to H-Link only if the transmitter is turned ON normally and then STOP is activated. Connection of H-Link PC application to transmitter doesn't require any additional hardware. It is done through a wireless data link.

3.4.3 Access code

Your Ergo 120 transmitter has software based functionality access safety feature to avoid the misuse of the transmitter. User is asked to enter this code each time he turns on the device. Device comes with access code 1234 as default which can be updated using H-Link or when in Service mode. This feature can also be disabled by assigning the value as 0000.

3.4.4 Switches

Your Ergo 120 transmitter can have 10 front and 4 side switches (for V1 and V2 type). These switches can be configured using the H-Link DK tab and each switch can be assigned with 3 different DK's.

3.4.5 Power Switch

Your Ergo 120 transmitter power button (S15) is placed on top right corner. This same switch is used both to switch ON your Ergo 120 and switch OFF when in Operation mode.

Your Ergo 120 power button needs to be pressed only once to turn ON your transmitter while it needs to be held pressed for a pre-set time duration to turn OFF the transmitter. This duration can be set in H-Link DK tab.

3.4.6 Proportional Switch (Optional)

Ergo 120 can have two proportional switches. These are connected to the analog inputs of the Ergo 120 coder board. These switches can be enabled from the DK tab and configured to AK signal using AK-DAK tab. Configuration for these switches are

Parameter	Description
Telegram AK	AK1-AK9
Signal	Analog input 1 or Analog input 2 (Proportionate switch)
Type	0-Vref or Vref/2 (127)
Dir A (only for Vref/2)	DK1-DK32 (to increase the AK value up to 248)
Dir B (only for Vref/2)	DK1-DK32 (to decrease the AK value up to 8)
Switch Sensitivity Level	0-100% (Low sensitive will change AK values faster)

Table 2. Analog configuration parameters

3.4.7 Communication parameters

Following are the standard communication parameters which can be set using H-Link for your Ergo 120 transmitter.

Parameter	Description
Address	<ul style="list-style-type: none"> 0-999999
Telegram Type	<ul style="list-style-type: none"> 32DK 32DK + 8AK 80DK + 2AK
Radio Module	<ul style="list-style-type: none"> CS419TR CS429TR CS434TR CS458TR CS868TR CS434TXN CS458TXN CS480TR CS1216TR CS2400TR MFS2G4
Frequency	Standard frequencies for each RF module
Low Battery Warning	Short, Medium, Long
TX Baud	2400 – 115200bps
Auto off	1min – 1hour
Feedback	Disabled, Half duplex, Full duplex
DK sync1	DK2 – DK30
DK sync2	DK2 – DK30
Interval	0-30
HD Baud	TxBaud, 2400 – 115200bps
FB Delay	1 – 100ms
FD Baud	TxBaud, 2400 – 115200bps
Radio Module	Standard Hetronic RF module range
Frequencies	Standard frequencies for RF module
Primary MFS channel	MFS channel Standard channels for MFS 2.4Ghz (1-16)
Secondary MFS channel	MFS channel Standard channels for MFS 2.4Ghz (1-16)
Duty cycle	1%-10%

Table 3. Radio parameters

N.B. For setting specific RF channels/groups refer to respective frequency table in RF module appendix.

3.4.8 TFT (if equipped)

Your Ergo 120 transmitter's TFT has following display features.

1. Splash Screen (Logo)

Splash screen is the Logo that will be displayed during start up. The Hetronic Logo will be programmed as a default factory setting. This can be enabled or disabled using 'LCD Splash screen' in Feedback tab of PC H-Link.

2. Splash screen duration

Splash screen (logo) duration can be set from the 'On time' field in the Feedback tab on H-Link.

3. Time & Date

Time displayed on the status bar of your Ergo 120 transmitter can only be in 24hrs format. This can be updated either through PC H-Link, User control tab or through service mode.

4. Received Signal Strength Indicator (RSSI)

Received signal strength is displayed on status bar of your Ergo 120 transmitter and indicates the transmitter signal strength (If feedback is enabled then it shows the strength of the receiver signal).

5. Battery Level

Battery level is displayed on TFT and its low voltage detection threshold can be set through the 'Low Batt Warning' field in RF tab of PC H-Link.

6. STOP message

Stop message is activated when the STOP button (S16) is pressed.

7. Feedback Messages

Feedback message can be of three types:

1. None: TFT will Display all the 32DK's. By pressing any of the switches, respective assigned DK will be highlighted.

2. Standard TFT Feedback: LCD will display standard Hetric 16bit LED feedback. This mode of feedback can trigger up to 8 different types of graphic icons. Source of the LED trigger can be either DK's or Logic gate results or AK error or feedback from the receiver. The parameters for this mode can be configured through the Feedback tab in PC H-Link.

3. Standard Feedback: TFT will display the standard Hetric text/graphic mode with position. This mode can work with full and half duplex by sending the correct communication parameters with the receiver.

This feature can be configured using the 'LCD Mode' in the feedback tab of the H-Link software.

8. Customizable Display

The display's background colour, logo, graphics, feedback images, text and status bar can all be configurable using a custom graphics programming tool which can be provided upon request.

// add images

3.4.9 Device status

Your Ergo 120 transmitter's switches and communication parameters can be monitored from the PC H-Link device status tab. All the configured parameters must be cross checked before using the transmitter with any receiver.

3.4.10 USB

The Ergo 120 transmitter's USB is used for following features

1. Updating firmware: Memory key has to be replaced with USB cable to be able to update the firmware in Boot loader mode.
2. Charging the battery: Your Ergo 120 transmitter can be charged using any USB source (max 1amp current). It charges the battery at the rate of 350mA per hour.
3. Power bank: Can be plugged with power bank to operate the transmitter without battery (In current design power switch is bypassed for this feature).
4. Basic Configuration: The basic configuration settings can also be set by connecting to a USB port on a PC or saved on a USB flash drive and inserted in the Transmitter before switching it on. The USB flash drive can serve as a key before starting to operate the device.

3.4.11 Cable Control

Cable control is also possible on Ergo 120 Transmitters and the following three cable options are available to choose from depending on the application:

- a) CAN without termination jumper
- b) CAN with termination jumper
- c) RS232

3.4.12 Belt Clip and Holster

The practical belt clip allows the user to hang the Ergo 120 transmitter and continue operation hands free or store the transmitter hung vertically when not in use.

The holster can be ordered as an add-on, with or without the belt, so as to protect the transmitter from undue damage.

4. Theory of Operation

Your Ergo 120 transmitter works with a receiving device to transfer machine control commands via radio frequency to your machine. The transmitter electronically generates a carrier frequency that allows it to communicate with the receiver without the use of cables or wires. The receiver then converts the carrier frequency information into discrete machine control outputs that interface with your machine's controls. Each transmitter and receiver that comprises a system is programmed with a unique address code. This code ensures that machine operations are safe, and that other remote control equipment cannot unintentionally control your machine. The receiver only accepts commands from the transmitter with the same address code. The receiver and transmitter have the address code set at the factory.

4.1 Stop Function

The most important feature of the radio remote control system is the STOP function. When the transmitter is turned on, it performs a self-test to confirm that communications are within designated parameters. If an error is detected, the transmitter will not transmit any signals. The transmitter sends the STOP pushbutton status along with the specified machine functions. This method confirms that ongoing operations are safe. If the STOP pushbutton is pressed, the data telegram changes so that only the stop command is transmitted. No other motion command data is sent.

This special data telegram places the receiver in Safe Mode, and the stop relays in the receiver open. All other machine functions are completely disabled in the receiver.

When the receiver is appropriately installed the STOP pushbutton will act as an emergency stop button and will shut down the controlled equipment completely.



Pressing the STOP pushbutton does not ensure the machine will stop. STOP button functionality is subject to the wiring of receiver STOP relays to machine emergency stop circuit.

ALWAYS test the STOP function at the beginning of every operation session or when there is change of operator.



Figure 3. Ergo 120 Transmitter

5. Changing the battery

You may power your transmitter with a Hetricon rechargeable battery inserted into the back of the transmitter. Follow the instructions below to ensure best performance of your Ergo 120 transmitter and prolonged battery lifetime.

1. Confirm that your batteries are fully-charged. See “Recharging Your Batteries” section.
2. Slide the recharged battery into the battery compartment on the back of the transmitter as shown, and snap it into place.

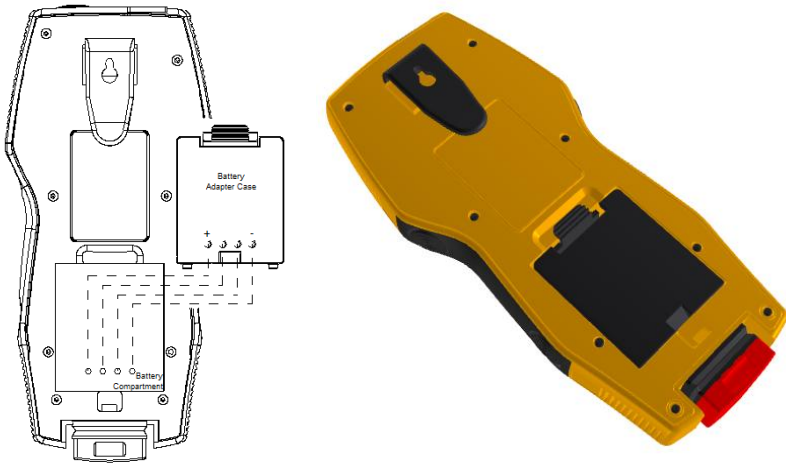

Figure 4. Inserting Battery

5.1 Recharging your Batteries

The LED labelled “CHARGE” flashes for two seconds, and then stays lit during the charging process. When the battery is fully charged, the “READY” LED lights up and the “CHARGE” LED goes off.

NOTE: Charging time could take up to 3.5 hours, depending on the condition of the battery.

Leave the battery in the charger until it is needed. The charger supplies a “trickle” charge but will not over-charge the battery.



EXPLOSIVE GASES AND FLYING DEBRIS can cause death or serious injury. Use only Hetricnic replacement rechargeable batteries. Use of unauthorized replacement batteries could cause a battery explosion resulting in injury or death of the operator or other people in the work area.

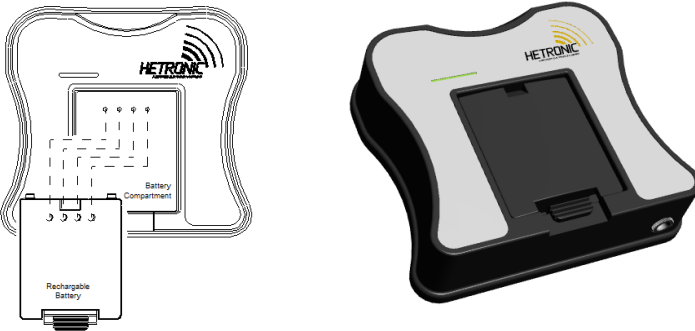

Figure 5. Battery Insertion in Charger

5.2 Battery Disposal

AVOID ENVIRONMENTAL POLLUTION. Recycle your rechargeable batteries according to local recycling rules and regulations. If you have questions or problems operating your battery charger, please contact your dealer or Hetricnic.

Standard Hetricnic rechargeable batteries are the Lithium polymer type. These batteries have no “memory effect” when charging a battery that is not fully discharged.

5.3 Prolonged Battery Life

Avoid battery misuse, over charging, overheating or regular dropping. This can cause permanent damage to the cells.



Never keep a fully charged battery at elevated temperatures. Battery pack does not die suddenly but the runtime gradually shortens as the capacity fades.



Keeping the charge in the 40°C to 80°C range is generally prolonging battery life.



If you are not using your device for a while, try keeping the battery at around 50% charged before turning it off. Keep it in a cool place (ideally under ~32°C /90°F)

Unfortunately there is no avoiding fact that battery has a finite life, after which they will certainly degrade. Following these basic tips can help delay the inevitable.

6. Operating Your Transmitter

6.1 Holding Your Transmitter

Hold the transmitter upright with the front facing you. Confirm that you are able to easily read and understand any operation text or symbols. Complete the following procedures once a day, before the start of an operation and at all shift changes.

6.2 Visually Checking Your Transmitter

Always check the transmitter for any physical damage before any operation. Check equipment for wear or damage and confirm that you can read and understand all of the safety labels. Never operate a transmitter with worn or damaged parts.

6.3 Powering Up and Starting Your Transmitter

NOTE: When the transmitter is not being used by the operator, it must be removed and stored in a safe place.

1. Confirm that all safety measures required by the equipment manufacturer have been followed.
2. Turn ON the receiver.
3. Insert a battery adapter with fresh batteries into the transmitter battery compartment.
4. Press **START** (S15). The following results will quickly appear in the order given in Table 4.
5. Access code: User needs to provide correct access code to start operating the transmitter.

Note: This can be changed/enabled when transmitter is in Service mode during operation or through PC H-Link.

6. Test all machine functions. Refer to your machine, transmitter and receiver documentation as needed.

Result	Meaning
Red & Green LEDs turn ON always.	Bootloader Mode.
Green LED Blinks at Baud rate.	Data is being transmitted.
Red LED Blinks at Baud rate.	Stop switch active. Stop Data is being transmitted.
Red & Green LED Blinks at Baud rate.	H-Link data transmitted to PC application.
Red & Green LED Blinks at fast rate.	Boot loader mode to update the firmware

Table 4. LED behaviour and Meanings

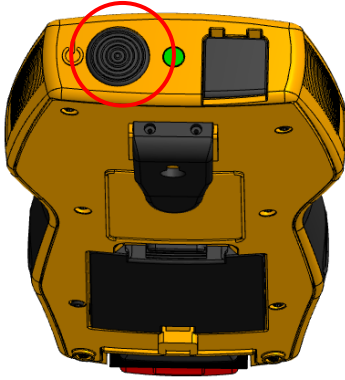

Figure 1. Starting the Transmitter

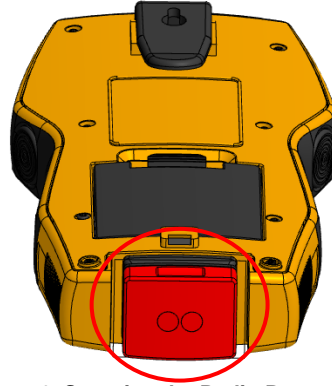

Figure 2. Stopping the Radio Remote Control

6.4 Stopping Radio Remote Control

Press **STOP**.

The word **STOP** appears and the transmitter sends an E-Stop telegram to the receiver for 2 seconds. Upon receiving the E-Stop telegram, the receiver goes into Safe Mode and turns OFF all receiver outputs. The transmitter shuts off in about 2 seconds.



WARNING: Holding the transmitter improperly while operating your machine could result in unexpected machine response.



WARNING: Test the stop function as described in the machine manufacturer's operator manual before beginning any operation.



WARNING: To avoid accidental start-up, always press STOP (Memory Key) when not in use.

Turn OFF your machine if there is a fault or problem with the safety check.

NEVER operate the machine if the stop function does not work properly.



WARNING: Improper operation, maintenance or adjustment may cause serious injury or damage to equipment and may void the warranty.

7. Troubleshooting

If your Ergo 120 does not operate after normal start-up, follow the recommended troubleshooting sequence to help isolate the cause and determine corrective action. If you need more information, contact your dealer or Hetricon.

PROBLEM	PROBABLE CAUSE	CORRECTION
Transmitter won't start	Incorrect Access code (if enabled)	Enter correct access code
	Battery fully discharged	Replace with fully charged battery
The transmitter is turned ON, but does not transmit (Power LED not flashing)	Battery is discharged	Replace battery with a fully charged battery
	Component failure	Contact your supervisor or nearest Hetricon Service Centre
Transmitter is transmitting (Power LED flashing), but machine will not respond	No power to the receiver	Check the diagnostic LEDs in the receiver to be sure power is applied. Ensure that the system is properly grounded
	Transmitter/receiver frequency channels do not match	Switch on transmitter in Service Mode to check channel or contact your supervisor
	Transmitter out of range	Take the transmitter back into the range of the receiver, press START
	Receiver power off	Turn on power to receiver
	Blown fuse in receiver	Check all fuses and replace if needed
	STOP failure in receiver. Red STOP LED on PC board is illuminated	Contact your supervisor
All machine motions operate intermittently	Receiver antenna connection is loose or missing	Tighten or replace antenna
	External antenna (if used) has loose connection, poor grounding or interference	Tighten antenna and ground connection. Contact Hetricon or your Dealer for more information
	Control wiring too close to high power machine wiring	Contact your supervisor
	Connector inside receiver is loose	Check all connectors, reseal if needed
	Another frequency may be interfering with the system	Contact your supervisor

Table 5. Troubleshooting tips

8. Specifications

Housing	Ergonomically designed Impact Resistant Polymer Composite
Environmental Protection	IP 65 (Exceeds Nema 12/13)
Weight	~480g (1.05lbs) including battery
Dimensions	Height: 234 mm (7.3 in.)
	Width: 107 mm (3.2 in.)
	Depth: 50 mm (1.3 in.)
Antenna	Internal
Power Supply	3.7V 3.2Ah Li-Po rechargeable battery
Diagnostics	Status LED for operation and standard/advanced low battery detection
Operation Time	Up to 16 h continuous transmission
Control Configuration	V1 – 14 single detent push buttons, start + stop
	V2 – 10 two detent push buttons, 4 single detent push buttons, start + stop
Frequency Range	4xMHz, 868MHz, 1.216GHz or 2.4GHz (subject to purchased configuration)
Power (RF Output)	< 10 mW E.I.R.P
Typical Operating Range	Typically 100 m. (320 ft.) for ≤ 1GHz, 50-60m (170 ft) for ≥ 1Ghz
Safety	20-bit programmable address concept with up to 1,000,000 combinations
	Hamming Distance 3
Operating Temperature Range	-20°C . . . 70°C (-4°F . . . 158°F)
Storage Temperature Range	-40°C . . . 75°C (-40°F . . . 167°F)
Humidity Range	0 - 97% maximum non-condensing
Response Time	Approx. 100 msec.
Standard Features	Fully programmable via PC H-Link
	USB Memory key that stores configuration settings
	Wrist strap

Table 6. *Technical Specification*

9. Warranty, Service, Repairs and Maintenance

Before any service or maintenance intervention on remote controlled equipment always:

- Remove all electrical power from the equipment
- Follow lock out procedures

Hetronic products are covered by a guarantee/warranty against material, construction and manufacturing faults. During the guarantee/warranty period, Hetronic may replace the product or faulty parts. Work under guarantee/warranty must be carried out by Hetronic, or by an authorized service centre specified by Hetronic. Any modification, reconstruction or extension of the systems without a written agreement of Hetronic may lead to the loss of your warranty and guarantee claims.

The following are **not** covered by the guarantee/warranty:

- Faults resulting from normal wear and tear
- Consumables
- Products that have been subject to unauthorized modifications
- Faults resulting from incorrect installation and use

Maintenance

- Repairs and maintenance must be carried out by qualified personnel.
- Only use spare parts from Hetronic.
- Contact your representative for service or any other assistance.
- Keep the product in a clean, dry place.
- Keep contacts and antennas clean.
- Wipe off dust using a slightly damp, clean cloth.

NOTE! Never use abrasive cleaning solutions or high-pressure water jets.

10. Regulatory Information

Europe

CE Marking

Hetronic hereby declares that the radio equipment types listed in this manual are in compliance with Directive 2014/53/EU.

The latest version of the complete EU Declaration of Conformity is available on the Hetronic website www.hetronic.com.

QR code

WEEE Directive



This symbol means that inoperative electrical and electronic products must not be mixed with household waste. The European Union has implemented collection and recycling system for which producers are responsible. For proper treatment, recovery and recycling, please dispose of the product in a designated collection point.

Reach Compliance

Hetronic confirms that, to the best of its knowledge and continual communication with its respective suppliers, chemical Substances of Very High Concern (SVHC) are not included in our products. Based on the response statements of our suppliers no materials from the ECHA are included on Hetronic products. For the latest version of the complete Declaration of Conformity please visit the Hetronic website www.hetronic.com.

RoHS Compliance

As a designer and manufacturer of electrical and electronic products covered by RoHS and RoHS2, Hetronic confirms that to the best of its knowledge at the date of this statement, none of the products supplied by it contain any of the hazardous substances in excess of permitted levels referred to in the Directive 2002/95/EC. The latest version of the complete Declaration of Conformity is available on the Hetronic website www.hetronic.com

North America

FCC Recommendations: (only valid for equipment that works in 915MHz ISM band)

This device complies with Part 15 of the FCC Rules. Operation is subject to the following two conditions:

1. This device may not cause harmful interference, and
2. This device must accept any interference received, including interference that may cause undesired operation.

Changes or modifications not expressly approved by the manufacturer could void the user's authority to operate the equipment.

To comply with FCC RF exposure compliance requirements, this device and its antenna must not be co-located with, or operating in conjunction with, any other antenna or transmitter.

This equipment has been tested and found to comply with the limits for a Class A digital device, pursuant to Part 15 of the FCC Rules.

These limits are designed to provide reasonable protection against harmful interference when the equipment is operated in a commercial environment.

This equipment generates, uses, and can radiate radio frequency energy and, if not installed and used in accordance with the instruction manual, may cause harmful interference to radio communications.

Operation of this equipment in a residential area is likely to cause harmful interference in which case the user will be required to correct the interference at his own expense.

IC Statement

This product complies with Industry Canada's licence-exempt RSSs. Operation is subject to the following two conditions:

1. This device may not cause interference, and
2. This device must accept any interference, including interference that may cause undesired operation of device.

To satisfy IC RF exposure requirements, a separation distance of 20cm or more should be maintained between the antenna of this device and persons using device operation. To ensure compliance, operations at closer than this distance is not recommended.

The radio module in this product is labelled with its own FCC ID and IC number. The FCC ID and IC is not visible when the radio module is installed inside another device. Therefore, the outside of the device into which the module is installed must also display a label referring to the radio module. The final end device must be labelled in a visible area with the following:

"Contains FCC ID: ONFC1108B"

"Contains IC: 4807A-C1108B"

Or

"Contains FCC ID: ONFC1203B"

"Contains IC: 4807A-C1203B"

FCC/IC label placement

The FCC/IC label is placed on the radio module. The radio module is mounted inside the transmitter.



www.hetronic.com

© 2017 Hetronic

All rights reserved. No part of this publication may be reproduced, transmitted, transcribed, stored in a retrieval system, or translated into any language in any form by any means without the written permission of Hetronic.

Technical information subject to change without notice.

Hetronic reserves the right to discontinue, make changes to, and add improvements upon its products at any time without public notice or obligation. Hetronic disclaims liability for any claims or damages, whether regarding property, personal injury or death arising out of the use of unauthorized replacement parts or service.